

Varenummer: 0110081
 Beskrivelse: Seeger låsering JS 68X3
 Fjederstål

Mål

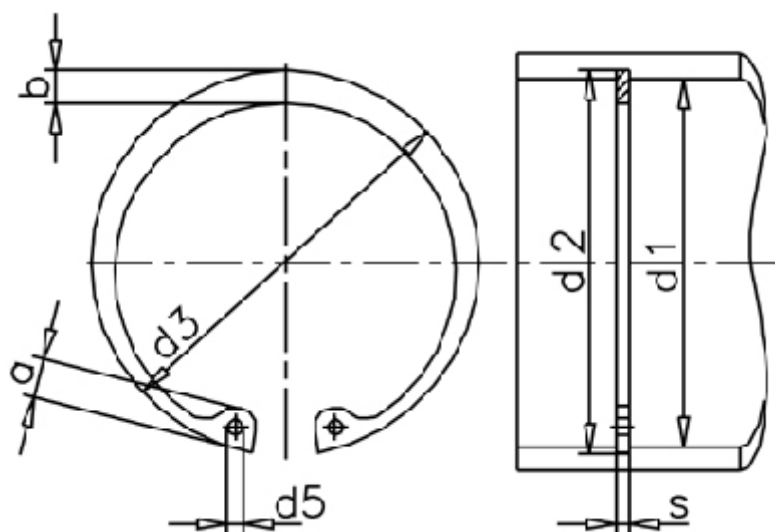

a max	= 8.8	d5 min	= 3.0	t	= 1.50
AN mm ²	= 327	FN kN	= 54.5	Tang	= ZGJ-3
B	= 1.44	FRg kN	= 30.6	tol	= 0.30
b	= 6.1	FR kN	= 174.0	tol	= +1,10 -0,46
Betegnelse	= JS 68	g	= 2.5	tol	= -0.08
d1	= 68	m min	= 3.15	vægt kg/1000	= 17.2
d2	= 71.0	Nominel træk	= 4.5		
d3	= 72.5	s	= 3.00		